

LMV Series LED Drivers VEL18XXXMVH-11

Constant Current



Descriptions:

The LMV series of LED drivers offer the perfect power to fixtures in any severe environment. Accurate constant current design keep the performance with high efficiency. Metal housing provides best heatsinking to guarantee the long life operation.

Features & Benefits:

- Universal Voltage (120-277V)
- Outdoor Type 1
- Constant Current
- 0-10V Dimming
- Integrates with Adaptive Lighting Control Systems
- Compatible with LED modules
- UL, cUL, UL8750 Class 2
- FCC Part 15 Class A
- Operating Temperature: -22°F to 122°F
- Storage Temperature: -40°F to 131°F

Specifications:

Ordering Code	Max Output Power	Max Output Voltage	Output Current (mA)	Input Voltage	Power Factor	Min Starting Temp (C)	Dimming	System Efficacy	IP Rating
VEL18035MVH-11	18	33-52	350	120-277	>0.90	-30	None	80	IP54

Dimensions:

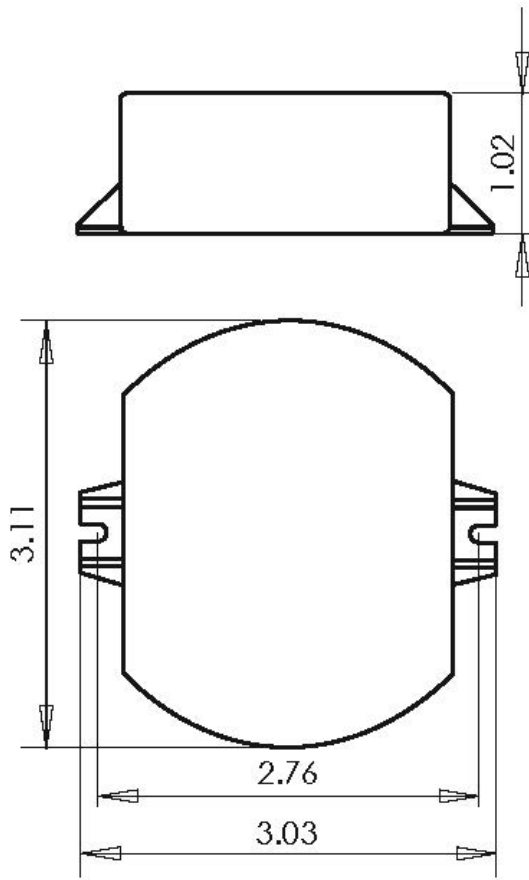

Ordering Code	Length (in)	Width (in)	Height (in)	Mounting (in)	Input Black Lead (in)	Input White Lead (in)	Output Red Lead (in)	Output Yellow Lead (in)
VEL18035MVH-11	3.03	3.11	1		6	6	6	6

Wiring Diagram:

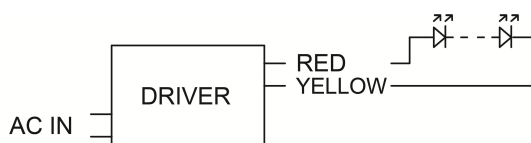

Specification data is based on tests performed in a controlled environment and represents relative performance. Actual performance can vary depending on operating conditions. Application and performance data subject to change without notice. All specifications are nominal unless noted otherwise.