

Power Selectable VersaKit Troffer Retrofit Kit

VEKT2X4L-8XX (29W/32W/36W)

Commercial Grade LED Retrofit Kit



Descriptions:

This advanced troffer retrofit kit easily converts fluorescent troffers to the most current LED technology. Its ultra high efficiency reduces energy costs. It is one of the LED troffer retrofits that comes completely assembled as a lensed kit, requiring only one minute to install, reducing labor costs. The retrofit kit is also 0-10V Dimmable with 5 Year Warranty. Ideal applications include: office, retail, healthcare, education and hospitality interiors. 3 selectable power levels offers the choices of proper illumination level or energy savings.

Features & Benefits:

- Performance
The VEK series uses the latest LED technology and LED driver to ensure steady performance and long lifetime.
- Installation
The Troffer Retrofit Kit provides the ideal way to replace existing recessed troffer, utilizing the existing fixture housing. The kit provides all the components needed to perform the change out quickly and efficiently, allowing for system upgrades without disturbing the ceiling. The LED troffer retrofit is completely assembled within the frame. With special 2-in-1 design, the kit fits for both air return troffers and standard troffers.

Specifications:

Ordering Code	Type	System Wattage	System Lumens	CCT (K)	System Efficacy	CRI	Input Voltage	Dimming	THD	Power Factor
VEKT2X4L-835 (29W/32W/36W)	2X4	29/32/36	3625/4000/4500	3500	125	>80	120-277	0-10V	<20%	0.9
VEKT2X4L-840 (29W/32W/36W)	2X4	29/32/36	3625/4000/4500	4000	125	>80	120-277	0-10V	<20%	0.9
VEKT2X4L-850 (29W/32W/36W)	2X4	29/32/36	3625/4000/4500	5000	125	>80	120-277	0-10V	<20%	0.9

Wiring Diagram:

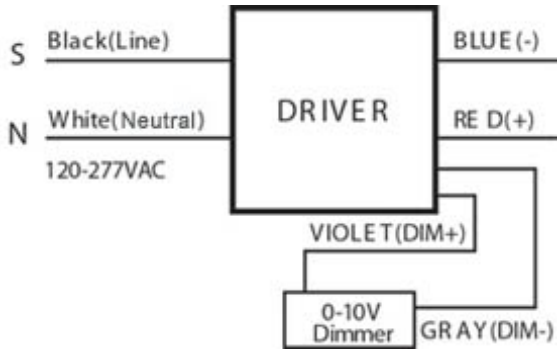

DLC Listing:

Ordering Code	DLC Product ID	DLC Product Model	DLC Version
VEKT2X4L-835 (29W/32W/36W)	N/A	N/A	N/A
VEKT2X4L-840 (29W/32W/36W)	N/A	N/A	N/A
VEKT2X4L-850 (29W/32W/36W)	N/A	N/A	N/A

Specification data is based on tests performed in a controlled environment and represents relative performance. Actual performance can vary depending on operating conditions. Application and performance data subject to change without notice. All specifications are nominal unless noted otherwise.